



Please read this document carefully before using this product. The guarantee will be invalidated if the device is damaged by not following instructions detailed in the manual. The company shall not be responsible for any damage or losses however caused, which may be experienced as a result of the installation or use of this product.

ENDA ET4410 PID TEMPERATURE CONTROLLER

Thank you for choosing ENDA ET4410 temperature controller.

- * 48 x 48mm sized.
- * Double set point can be selected.
- * Selectable thermocouple types.
- * Automatic calculation of PID parameters. (SELF TUNE).
 - The system before starting the first time, the system PID parameters should be entered if known, otherwise Self-Tune property must not be operated.
- * Digital inputs can be assigned to 3 different feature.
- * Function key can be assigned to 3 different feature.
- * Soft-Start feature.
- * Selectable analog, SSR, relay or motorized valve control output.
- * Selectable 0-20mA and 4-20mA retransmission output.
- * Selectable 0-20mA and 4-20mA analog control output.
- * Alarm2 or temperature control output can be programmed as C/A2 relay output.
- * Alarm1 output or PID cooling output can be programmed
- * Selectable heating and cooling control
- * For input offset feature.
- * In the case of probe failure periodical running or relay state can be selected.
- * Communication with RS-485 ModBus protocol.



TECHNICAL SPECIFICATIONS

Input type		Temperature range		Accuracy
		°C	°F	
J (Fe-CuNi) Thermocouple	EN 60584	0... 600°C	+32... +1112°F	± 0,5% (of full scale) ± 1 digit
K (NiCr-Ni) Thermocouple	EN 60584	0...1300°C	+32... +2372°F	± 0,5% (of full scale) ± 1 digit
T (Cu-CuNi) Thermocouple	EN 60584	0... 400°C	+32... +752°F	± 0,5% (of full scale) ± 1 digit
S (Pt10Rh-Pt) Thermocouple	EN 60584	0...1700°C	+32... +3092°F	± 0,5% (of full scale) ± 1 digit
R (Pt13Rh-Pt) Thermocouple	EN 60584	0...1700°C	+32... +3092°F	± 0,5% (of full scale) ± 1 digit

ENVIRONMENTAL CONDITIONS

Ambient/storage temperature	0 ... +50°C/25... +70°C (with no icing)		
Max. Relative humidity	80% up to 31°C decreasing linearly 50% at 40°C.		
Protection class	According to EN 60529	Front panel :	IP65
		Rear panel :	IP20
Height	Max. 2000m		



Do not use the device in locations subject to corrosive and flammable gases.

ELECTRICAL CHARACTERISTICS

Supply	230V AC +10% -20%, 50/60Hz or 24V AC ±10%, 50/60Hz.
Power consumption	Max. 5VA
Wiring	Power terminal: 2.5mm ² screw-terminal connections. Signal terminal: 1.5mm ² screw-terminal
Line resistance	For thermocouple max. 100ohm
Data retention	EEPROM (minimum 10 years)
EMC	EN 61326-1: 1997, A1: 1998, A2: 2001 (Performance criterion B for standard EN 61000-4-3)
Safety requirements	EN 61010-1: 2001 (Pollution degree 2, overvoltage category II)

OUTPUTS

C/A2 output	Relay : 250V AC, 2A (for resistive load), NO+NC (Selectable as control and Alarm2.)
A1 output	Relay : 250V AC, 2A (for resistive load), NO (Selectable as Alarm1 and cooling control)
ANL/SSR output	Selectable as 0-20mA, 4-20mA analog output and logic control output
Life expectancy for relay	Without load switching 30.000.000 mechanical operation ; 250V AC, on the 2A resistive load 300.000, electrical switching

CONTROL

Control type	Single set-point and alarm control
Control algorithm	On-Off / P (selectable)
A/D converter	12 bit
Sampling time	500ms
Proportional band	Adjustable between 0% and 100%. If Pb=0, On-Off control is selected.
Integral time	Adjustable between 1 and 250 seconds.
Hysteresis	Adjustable between 1 and 50°C/F.
Output power	The ratio of power at a set point can be adjusted between 0% and 100%

HOUSING

Housing type	Suitable for flush-panel mounting according to DIN 43 700.
Dimensions	W48xH48xD87mm
Weight	Approx. 250g (after packing)
Enclosure material	Self extinguishing plastics.



While cleaning the device, solvents (thinner, benzine, acid etc.) or corrosive materials must not be used.

up to date: 06.05.2019, modification reserved and can be change any time previous notice !

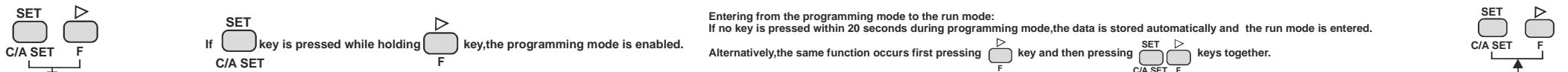

- C5Lo** = C/A1 output. Control set value lower limit. Parameter value can be set between 0-**C5Hi**.
- C5Hi** = C/A1 output. Control set value upper limit. **C5Lo** parameter value can be set between indicated value and the upper scale.
- C.Pb** = C/A1 output. Proportional band value. Adjustable between 0%-100%. **C.Pb** = 0 use On-Off control is selected.
- CHY5** = Hysteresis of the C/A1 output. Adjustable between 1-50 °C. **CHY5** = 0 this parameter is seen.
- C.ti** = C/A1 output integral value. Adjustable between 0.0-100.0 minute. **C.ti** = 0.0 effect of integral disable.
- C.td** = C/A1 output derivative value. Adjustable between 0.00-25.00 minute. **C.td** = 0.0 effect of derivative disable.
- C.Ct** = C/A1 output period time. Adjustable between 1-250sn. **C.Pb** parameter is different from "0", this parameter appears.
- CPSt** = At C/A1 Set value, C/A1 percent of power; Adjustable between 0%-100%.
- CEP5** = At sensor failure, C/A1 percent of power; Adjustable between 0%-100%.
- 5St** = Soft starter timer set value. This parameter indicates the time to reach set point value when the device is first energised. Adjustable between 0 and 250 minutes. If 0 is selected, soft start feature will be enable and the device reaches set point value quickly. **Setting Pb = 0**, soft start feature will be disable.
- CtYP** = Control type selection. **CtYP = HEAT** means heating control. **C5tR = Cool** means cooling control.

- AL 1o**
 - R15L** = Alarm1 set value lower limit. Adjustable between 0 and **R15H** parameter value.
 - R15H** = Alarm1 set value upper limit. Adjustable between **R15L** parameter value and upper scale value.
 - R1HY** = Hysteresis of the Alarm1 output. Adjustable between 1-50°C.
 - R1tP** = Type of Alarm1. 6 kinds of functions can be selected. **indE** = Independent alarm, **dE** = Deviation alarm, **bAnd** = Band alarm (Band), **bAni** = Band with inhibition, **inLo** = A1 output independent cooling control, **rELo** = A1 output relative cooling control.
 - R1St** = Alarm1 output situation. If Alarm1 output Hi=A1 output is above the Alarm1 set value; on, **Lo**=A1 output is above the Alarm1 set value; off.
 - R1Er** = Alarm1 probe failure situation. **on**=A1 output probe failure; on, **oFF**=A1 output probe failure; off.
 - R1Pb** = A1 output, value of proportional band. Adjustable between 0%-100%. **R1Pb**= 0%, On-Off control is selected. **R1tP** parameter, **inLo** or **rELo** is selected, this parameter is activated.
 - R1ti** = A1 output integral value. Adjustable between 0.0-100.0 minute. **R1ti** = 0.0 effect of integral disable.
 - R1td** = A1 output derivative value. Adjustable between 0.00-25.00 minute. **R1td** = 0.00 effect of derivative disable.
 - R1Ct** = A1 output period time. Adjustable between 1-250sn. **R1tP** parameter **inLo** or **rELo** is selected, this parameter is activated.
 - R1P5** = At A1 Set value, A1 output percent of power. Adjustable between 0%-100%. **R1tP** parameter **inLo** or **rELo** is selected, this parameter is activated.
 - R1EP** = At A1 Set value, A1 output percent of power. Adjustable between 0%-100%. **R1tP** parameter **inLo** or **rELo** is selected, this parameter is activated.

- AL 2o**
 - R25L** = Alarm2 set value lower limit. Adjustable between 0 and **R25H** parameter value.
 - R25H** = Alarm2 set value upper limit. Adjustable between **R25L** parameter value and upper scale value.
 - R2HY** = Hysteresis of the Alarm2 output. Adjustable between 1-50°C.
 - R2tP** = Type of Alarm2. 4 kinds of functions can be selected. **indE** = Independent alarm, **dE** = Deviation alarm, **bAnd** = Band alarm, **bAni** = Band with inhibition.
 - R2St** = Alarm2 output situation. **H** = A2 output is above the set value; on, **Lo**=A2 output is above the set value; off.
 - R2Er** = Alarm2 probe failure situation. **on**=A2 output probe failure; on, **oFF**=A2 output probe failure; off.
- Conf.**
 - inPt** = Type of input selection. **FEcn**=J type, **ncnR**=K type, **c.cn**=T type. **P10**=S type, **P13**=R type thermocouple selection. This parameter varies when changing some parameters.
 - Unit** = The temperature unit. **°C**=°C, **°F**=°F. This parameter varies when changing some parameters.
 - FLtr** = Coefficient of digital filter. Adjustable between 1 and 35. If this parameter is 1, digital filter runs most quick. If the parameter is 35, the filter run most slow. The value of parameter should be increased in interference.
 - CoSE** = Control output selection. **CoSE** = Control output selection, **CoSE** = Digital input selection, **CoSE** = SSR output selection, **CoSE** = 0-20mA analog output selection, **CoSE** = 4-20 mA analog output selection, **CoSE** = Motorized valve output selection.
 - RCoE** = Time of full opening of the motorized valve. Adjustable between 2-300sn. **CoSE** parameter, this parameter is set to the selection of motorized value is activated.
 - RCoT** = Motorized valve control period. Adjustable between 1%-50%. **RCoE** time period of the control output as a percentage of the control value. This parameter is how often to run the valve setting often prevents unnecessary. **CoSE** parameter, this parameter is set to the selection of motorized value is activated.
 - RLo** = Analog output lower limit. Adjustable between 0%-100%. **CoSE** parameter, this parameter is set to the selection of analog output is activated.
 - RHo** = Analog output upper limit. Adjustable between 0%-100%. **CoSE** parameter, this parameter is set to the selection of analog output is activated.
 - oFF5** = Offset value. Offset value is added to the measuring value. This feature which is the point of measurement due to its distance measurement probe, is used to eliminate errors that might occur. Adjustable between -99 - 99°C. Normal value=0.
 - dAdr** = Device address (For RS485 connection) Adjustable between 1-247. This parameter is active devices with RS485 communications option.
 - bRud** = ModBus baud rate (For RS485 connection) Selectable off, 2400, 4800, 9600, 19200 ve 38400. This parameter is active devices with RS485 communications option.

- btun**
 - 5tCo** = Self tune control. **no**= Self tune is stopped, **5tCo**= Self tune is started. Yes message appears on the display, if the **F** key is pressed the selected is approved.
 - 5CoE** = Parameter of **btun** menu security level. **no**= Invisibile, **5tCo** = Modification can be done, **5tCo** = Only visible.
- SECU**
 - 5Cod** = Security menu access code. It should be 441.
 - 5CoE** = Parameter of **AL 1o** menu security level. **no**= Invisibile, **5tCo** = Modification can be done, **5tCo** = Only visible.
 - R25c** = Parameter of **AL 2o** menu security level. **no**= Invisibile, **5tCo** = Modification can be done, **5tCo** = Only visible.
 - Co5c** = Parameter of **Conf.** menu security level. **no**= Invisibile, **5tCo** = Modification can be done, **5tCo** = Only visible.
 - 5t5c** = Parameter of **btun** menu security level. **no**= Invisibile, **5tCo** = Modification can be done, **5tCo** = Only visible.
 - dEFP** = Parameter of **Conf.** menu security level. **no**= Parameter settings aren't changed.
- d.inC** = Digital input setting parameter. **nonE**= Digital input is closed, **Co5R**= Digital input is active; 2.set value is used, **nRnu**= If the digital input is activated; manual mode can be exceed, **d5Po**= If the digital input is activated; temperature indicator mode can be exceed.
- F.FEL** = Function key setting parameter. **nonE**= Function key is closed, **Co5R**= The function key is used with the 2.set value, **nRnu**= Manual mode can be exceed by using the function key, **d5Po**= Temperature indicator mode can be exceed by using function key.
- F.tR5** = Retransmission output control parameter. **oFF** = Retransmission output is closed, **0-20** = 0-20mA Retransmission output is open, **4-20** = 4-20mA Retransmission output is open. **Co5E** parameter **CoSE** or **RCoE** is selected; this parameter is activated.

Modification Of Parameter Diagram

When holding **SET** key, the value of parameter flashes and using **C/A SET** keys the requested value can be adjusted.

If **F** key is pressed and held 0.6 seconds, the value of the selected parameter changes rapidly. If waited enough, the value increases 100 at each step. After 1 second following the release of the key, initial condition is returned. The same procedure is valid for the decrement key.

TERMS

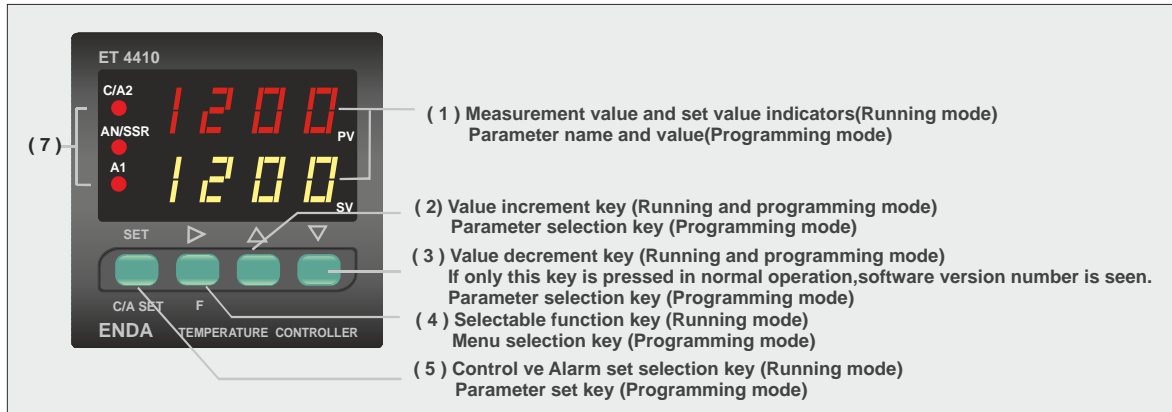

(1) PV and SV display	PV 7 segment 4 digits red ,SV 7 segment 4 digit yellow LED display
Character heights	PV display and SV display: 7.2 mm
(2),(3),(4),(5) Keypad	Mikro switch
(7) State indicator	Control,Alarm1 and SSR outputs for 3 red LEDs.

ALARM1 AND ALARM2 OUTPUT TYPES

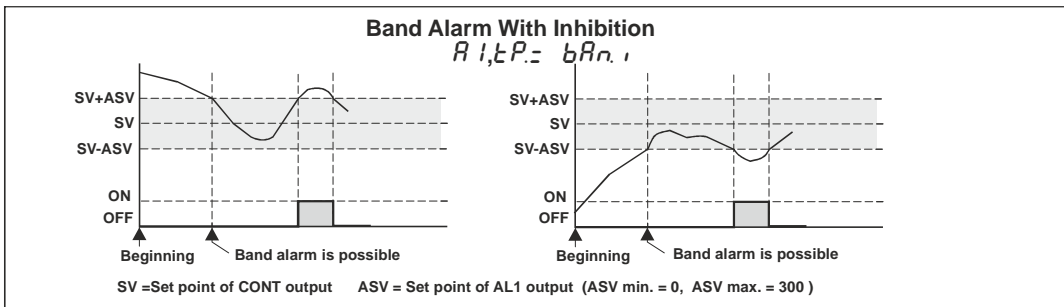
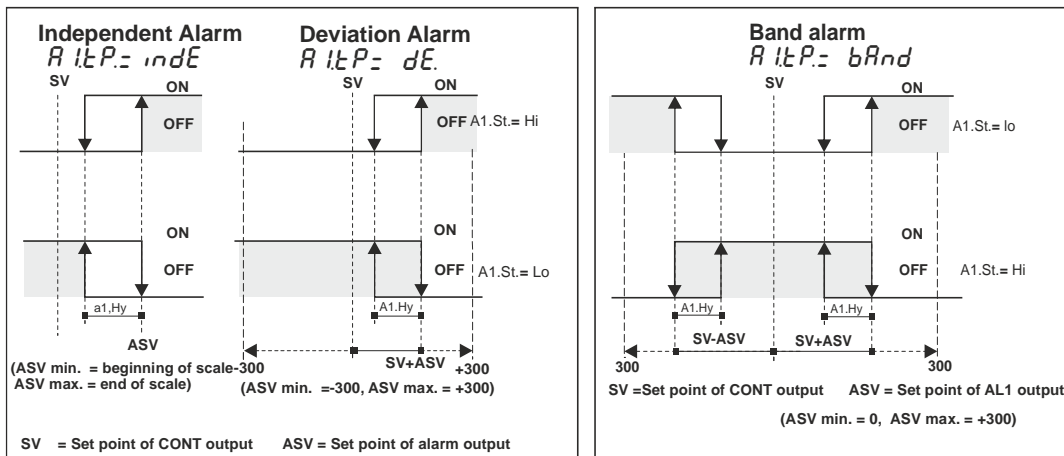

MODIFICATION OF CONTROL AND ALARM SET POINTS

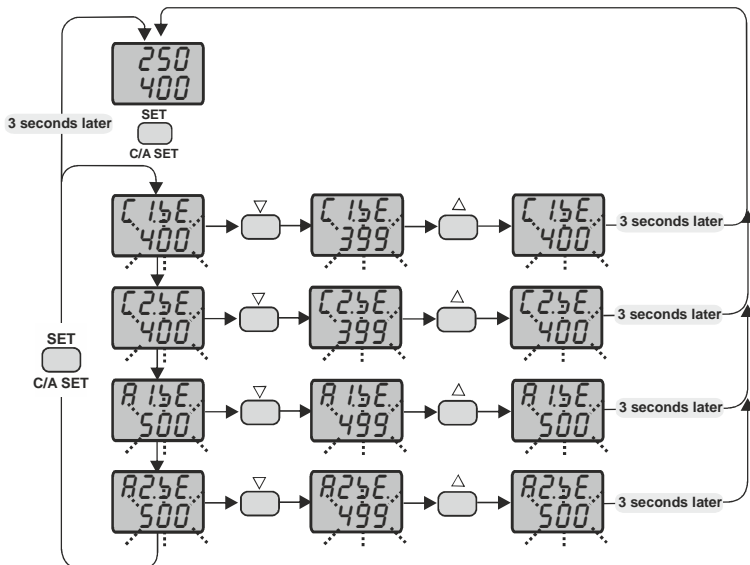

ERROR MESSAGES

PFA Temperature sensor is broken.

400 Temperature value is higher than the scale.

400 Temperature value is broken or over temperature.

One of the C2.S.A. parameter is set to d. i n C. or F F E C. this parameter is seen.

C. o s E. parameter, this parameter is set according to the SSR or analogue outputs.

MOTORIZED VALVE CONNECTION AND ADJUSTMENT

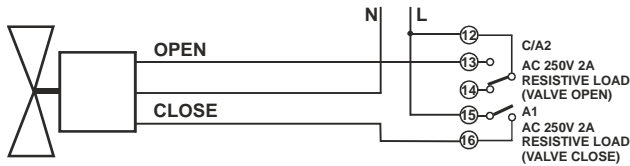

Motorized valve connection as shown in the figure above. (Output values of the electrical values of the valve is not suitable ignition device, additional contactor must be connected together.) Then, this device parameter, $R_{c.o.t.}$ is set to the selection of motor value. On full time motorized valve connected to a device, the $R_{c.o.t.}$ parameter is entered in seconds. How often the introduction of the valve is required, this value is also entered in the $R_{c.c.t.}$ parameter as a percentage of full time opening.

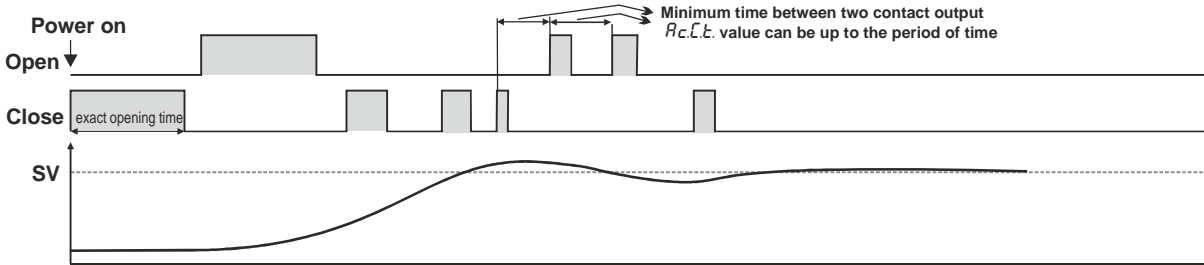

DIMENSIONS:

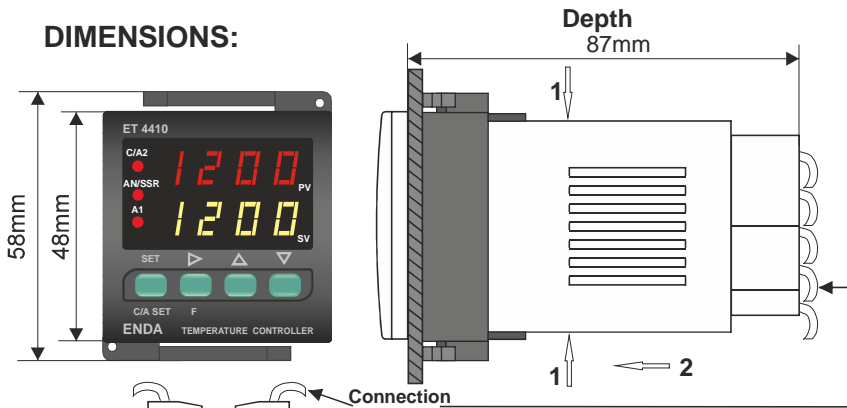

For removing the device from the panel:
- While pressing both side of the device in direction 1, push it in direction 2.



ENDA ET4410 is intended for installation in control panels. Make sure that the device is used only for intended purpose. The shielding must be grounded on the instrument side. During an installation all of the cables that are connected to the device must be free of energy. The device must be protected against inadmissible humidity, vibrations, severe soiling and make sure that the operation temperature is not exceeded. All input and output lines that are not connected to the supply network must be laid out as shielded and twisted cables. These cables should not be close to the power cables or components. The installation and electrical connections must be carried on by a qualified staff and must be according to the relevant locally applicable regulations.

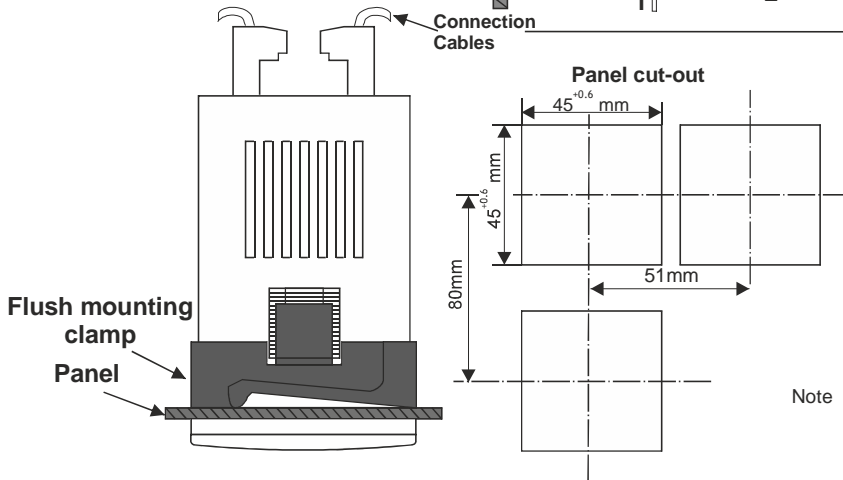

- Note 1) While panel mounting, additional distance required for connection cables should be considered.
2) Panel thickness should be maximum 9mm.
3) If there is no 100mm free space at back side of the device, it would be difficult to remove it from the panel.

CONNECTION DIAGRAM

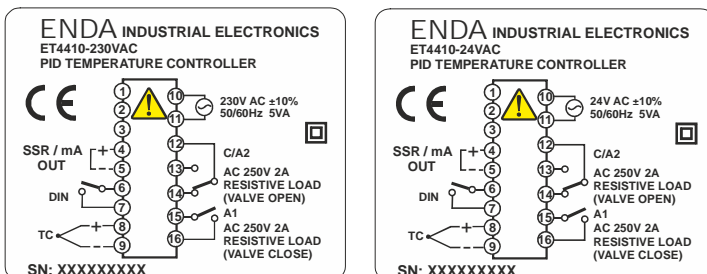

Logic output of the instrument is not electrically insulated from the internal circuits. Therefore, when using a grounding thermocouple, do not connect the logic output terminals to the ground.

- Note 1) Mains supply cords shall meet the requirements of IEC 60227 or IEC 60245.
2) In accordance with the safety regulations, the power supply switch shall bring the identification of the relevant instrument and it should be easily accessible by the operator.

Holding screw 0.4-0.5Nm

Equipment is protected throughout by DOUBLE INSULATION.

Order Code : ET4410- □□□□□□□□ / □□

- 1- Supply Voltage
230VAC...230V AC
24VAC.....24V AC

- 2- Modbus Option
RS.....RS-485 Modbus Communication
None...Don't support RS-485 ModBus Communication

NOTE :

SUPPLY VOLTAGE

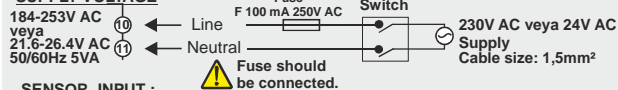

SENSOR INPUT :

For thermocouple :
Use suitable compensation cables. Don't use jointed cables. Pay attention to the polarities of the thermocouple cables as shown in the figure right are connected to the .

