



Please read this document carefully before using this product. The guarantee will be invalidated if the device is damaged by not following instructions detailed in the manual. The company shall not be responsible for any damage or losses however caused, which may be experienced as a result of the installation or use of this product.

ENDA ECUC411 Configurable Universal Converter

Thank you for choosing ENDA ECUC411 Configurable Universal Converter.

- * 4 Digits LED display.
- * TC, RTD, NTC, O, kO, mA, V, mV or frequency inputs.
- * Ambient temperature compensation.
- * Zero point input shift.
- * mA, V or frequency output selection.
- * 24V DC Sensor supply (Specify at order).
- * 3-Way isolation between input, output and supply.
- * Isolated RS485 Modbus RTU communication protocol feature (Specify at order).
- * Rail mounted.
- * Screw-terminal connections.
- * CE Marked according to European Norms.

CE
RoHS
Compliant



ORDER CODE

ECUC411-UV-RSI-24

Product Basic Code		Sensor Supply (Optional / Specify at order)
Configurable Universal Converter	ECUC411	
Supply Voltage		Communication (Optional / Specify at order)
60-250V AC / 85-300V DC	UV	
10-30V DC / 8-24V AC	LV	RSI Isolated RS485 ModBus

INPUTS						
Input Type	Scale	Accuracy	Input Resistance	Cable Color	Related Standard	
TC	B (Pt30Rh-Pt6Rh)	200 ... 1800°C 392 ... 3272°F	% ±0.1 and ±2°C (3,6°F)	Ri > 3k	+ Undefined - White	EN 60584
	E (NiCr-Con)	-100 900°C -148 ... 1652°F	% ±0.1 and ±0,5°C (1°F)		+ Purple - White	
	J (Fe-Con)	-100 900°C -148 ... 1652°F	% ±0.1 and ±0,5°C (1°F)		+ Black - White	
	K (NiCr-Ni)	-100 ... 1300°C -148 ... 2372°F	% ±0.1 and ±0,5°C (1°F)		+ Green - White	
	L (Fe-Con)	-100 900°C -148 ... 1652°F	% ±0.1 and ±1.5°C (2.7°F)		+ Red - Blue	DIN43710
	N (NiCrSi-NiSi)	-200 ... 1300°C -328 ... 2372°F	% ±0.1 and ±0,5°C (1°F)		+ Mauve - White	EN 60584
	R (Pt13Rh-Pt)	0 ... 1700°C 32 ... 3092°F	% ±0.1 and ±1°C (1.8°F)		+ Orange - White	
	S (Pt10Rh-Pt)	0 ... 1700°C 32 ... 3092°F	% ±0.1 and ±1°C (1.8°F)		+ Orange - White	
	T (Cu-Con)	-250 300°C -418 572°F	% ±0.1 and ±0,5°C (1°F)		+ Brown - White	
	U (Cu-Con)	-200 400°C -328 752°F	% ±0.1 and ±0,5°C (1°F)		+ Red - Brown	DIN43710
RTD	PT100	-200 850°C -328 1562°F	% ±0.1 and ±0,5°C (1°F)	Ri > 100k	Sensor current 250µA	EN 60751
NTC	NTC	-60 150°C -76 302°F	% ±0.1 and ±0,5°C (1°F)	Ri > 100k	Sensor current 250µA	
mA	0 - 20mA 4 - 20mA	% ±0.1 and ±1 digit	Ri < 50			
mV	0 - 150mV	% ±0.1 and ±20µV	Ri > 3k			
V	0 - 5V	-99,9 ... 999,9	% ±0.1 and ±1 digit	Ri > 3k		
	1 - 5V	-9,99 ... 99,99				
	0 - 10V	-9,99 ... 9,999				
kHz	0 - 550	% ±0.2 and ±0.1	Ri > 100k		Sensor current 250µA	
	0 - 10k	% ±0.5 and ±10				
kHz	0 - 10kHz	0 - 9999	% ±0.5 and ±1 digit	Ri > 10k	Between 5V and 30V pulse.	

ELECTRICAL CHARACTERISTICS

Supply	ECUC411-UV : 60-250V AC, 50/60Hz / 85-300V DC ECUC411-LV : 10-30V DC / 8-24V AC, 50/60Hz
Power Consumption	7VA Max.
Line Resistance	Up to 100Ω for thermocouple, up to 20Ω for 3-wire PT100
A/D Converter	16 bit
D/A Converter	13 bit
Sensor Supply	24V DC, up to 30mA, unregulated and short circuit protection (Optional / Specify at order).
Wiring	2.5mm ² Screw-terminal connections
EMC	EN 61326-1: 2013
Safety Requirements	EN 61010-1: 2010 (Pollution degree 2, over voltage category II)

OUTPUTS

mA	0-20mA DC or 4-20mA DC, % ±0,5 (Maximum load resistance 300Ω.)
V	0-10V DC, 0-5V DC or 1-5V DC, % ±0,5 , Maximum 10mA (short-circuit protection.)
Frequency	0-50kHz, % ±0,3 , 12V pulse

ENVIRONMENTAL CONDITIONS

Ambient/Storage Temperature	0 ... +50°C/-25 ... 70°C (Must be no icing and no condensation in the environment).
Max. Relative Humidity	Relative humidity 80% for temperatures up to 31°C decreasing linearly to 50% relative humidity at 40°C. (Must be no condensation in the environment).
Rated Pollution Degree	IP20 according to EN 60529 standards.
Height	En çok 2000m

⚠ KEEP AWAY device from exposed to corrosive, volatile and flammable gases or liquids and DO NOT USE the device in similar hazardous locations.

HOUSING

Housing Type	Suitable for TH35 type rail mounting according to EN 60715.
Dimensions	W25xH97xD115mm
Weight	Approx. 150g After packing.
Enclosure Material	Self extinguishing plastics.

⚠ Avoid any liquid contact when the device is switched on. DO NOT clean the device with solvent (thinner, gasoline, acid etc.) and / or abrasive cleaning agents.

CONNECTION DIAGRAM

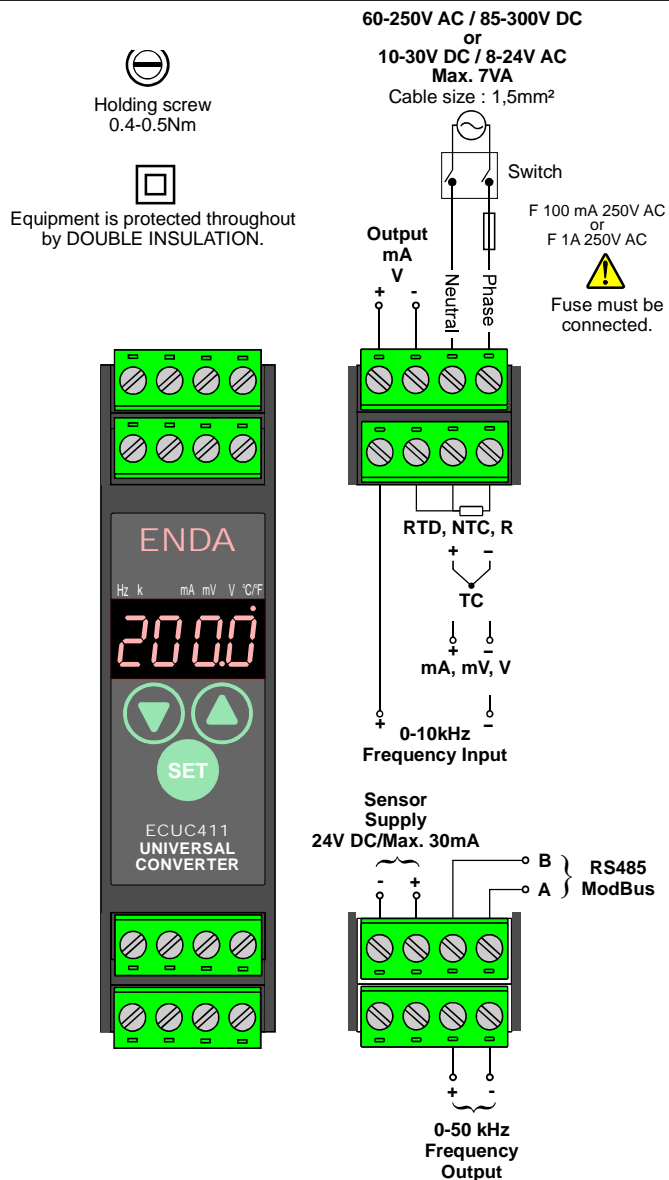
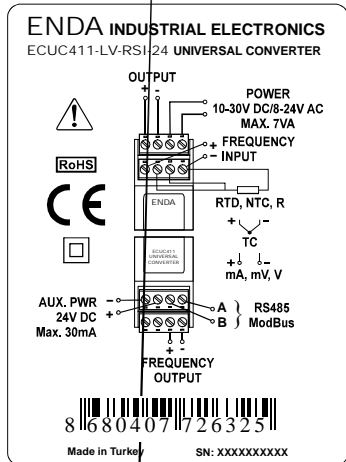
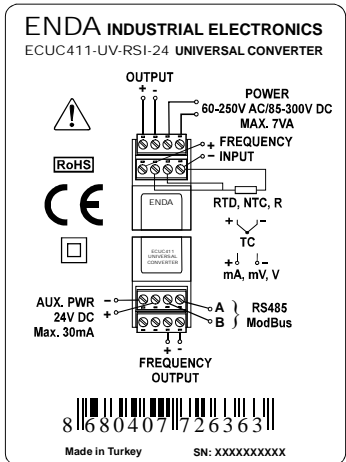
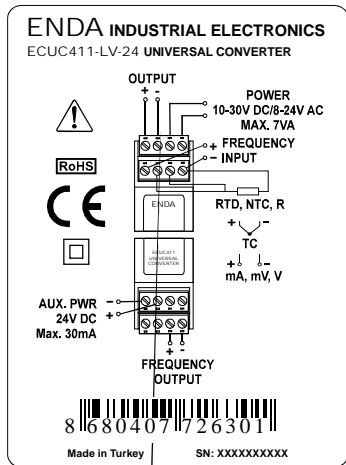
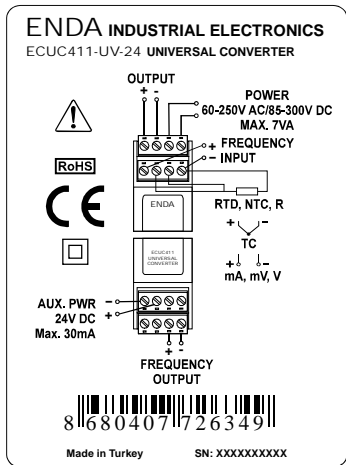

i Please see "Modbus Connection Diagram" on page 5 for details.

- !** 1) Mains supply cords shall meet the requirements of IEC 60227 or IEC 60245.
- !** 2) In accordance with the safety regulations, the power supply switch shall bring the identification of the relevant instrument and it should be easily accessible by the operator.

! ENDA ECUC411 Series converters are rail mountable devices. Make sure that the device is used only for intended purpose. The shielding must be grounded on the instrument side. During an installation, all of the cables that are connected to the device must be free of energy. The device must be protected against inadmissible humidity, vibrations, severe soiling and make sure that the operation temperature is not exceeded. All input and output lines that are not connected to the supply network must be laid out as shielded and twisted cables. These cables should not be close to the power cables or components. The installation and electrical connections must be carried on by a qualified staff and must be according to the relevant locally applicable regulations.

DIMENSIONS

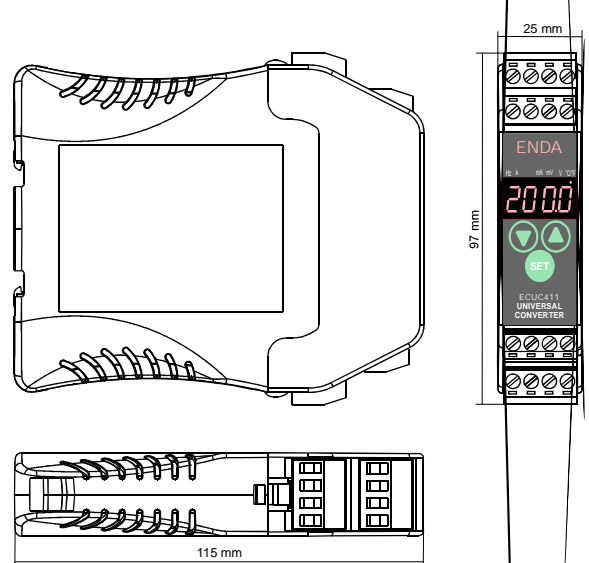

MONTAGE

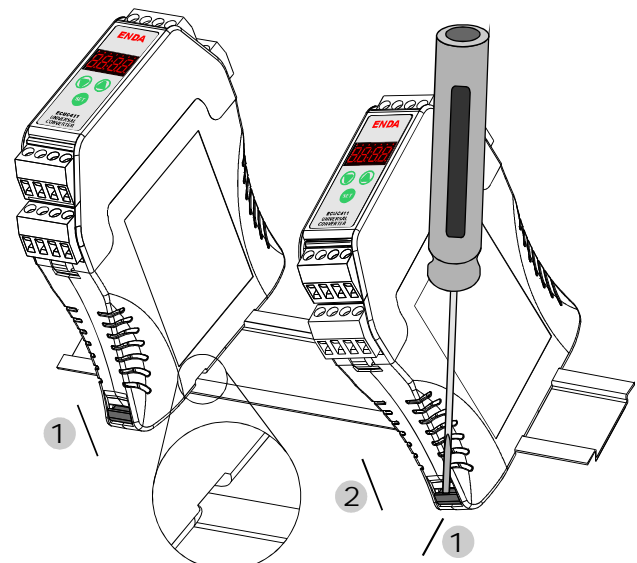

- To mounting the device on rail ;**
- Push the device to rail in direction **1** and make sure that the rail lock is interlocked to rail.
- To removing the device from rail ;**
- Push the rails lock in direction **1** with a screwdriver and pull the device in direction **2**

TERMS

? LED illuminates, if the **0-550? Resistor** measurement input type is selected.

k? LED illuminates, if the **0-10k? Resistor** measurement input type is selected.

Hz LED illuminates, if the **0-10kHz Frequency** measurement input type is selected.

mA LED illuminates, if the **0/4-20mA Current** measurement input type is selected.

mV LED illuminates, if the **0-150mV Millivolt** measurement input type is selected.

V LED illuminates, if the **0-5V, 1-5V or 0-10V Volts** measurement input type is selected.

°C/°F LED illuminates, if TC, RTD or NTC temperature measurement input type is selected. Continuously illuminates when °C unit is selected. Blinks when °F unit is selected.



SET Indicates the output signal value in "Running Mode".
Indicates the selected parameter value in "Programming Mode".

▲ Provides to shift to the next parameter in "Programming Mode".
increases the parameter value when a parameter adjusting. If pressed continuously, parameter value increases rapidly.

▼ Provides to shift to the previous parameter in "Programming Mode".
decreases the parameter value when a parameter adjusting. If pressed continuously, parameter value decreases rapidly.

▲ ▼ SET If all three keys are pressed in operation mode, device software version appears.

i "Running Mode" also means "Home Screen" and in this section, the present measured value is displayed.

Set Key Function in Running Mode

SET If set key is pressed during "Running Mode", present output signal value is displayed for 5 seconds. If no operation is performed in 5 seconds, "Running Mode" is returned.

If output type (Otyp) is selected as V or mA, output value is displayed as 2 digits after the decimal place.
For example ; (input type) ityp = 0-10 (0-10V), (output type) otyp = 0-5 (0-5V)

Lower scale value (in percentages) = 0 , Upper scale value (in percentages) = 100 . If 5V is applied to input, 50 is displayed, 2.5V is taken from the output and 2.50 is displayed when set key is pressed.

If output type (Otyp) is selected as (frequency) frEq , output will be 0-50kHz. : Decimal place not displayed at 0Hz to 100Hz. For 1kHz to 50kHz, output value is displayed as 2 digits after the decimal place.

For example ; If output is 300Hz, 300 is displayed. If output is 25kHz, will be displayed as 25.00 .

Locking and Unlocking Keypad

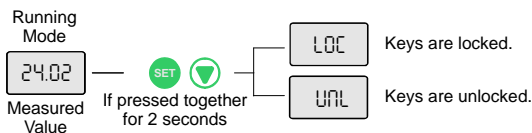

During "Running Mode", if **SET ▼** keys are pressed together for 2 seconds, Loc message appears and the keys are locked. If **SET ▲** keys are pressed together for 2 seconds while the keys are locked , unL message appears and the keys will be unlocked. By pressing **SET** key during the keys are locked, output signal value can be displayed. If any key is pressed (except **SET** key) while the keys are locked, the Loc message is displayed.

Programming

During "Running Mode", if **▲ ▼** keys are pressed together for 2 seconds, "Programming Mode" is entered and ityp parameter appears. By pressing **SET** key, parameter value will appears for 3 seconds. Displayed parameter can be changed by using **▲ ▼** navigation keys. If no operation is performed for 3 seconds while the parameter value is displayed, or **SET** key is pressed, it will be returned to the present parameter name (parameter values will be stored when 3-second period is exceeded or **SET** key is pressed). In "Programming Mode", if no operation is performed for 15 seconds or by pressing **▲ ▼** keys together while the parameter name is displayed, it will be returned to the "Running Mode".

i Parameter programming should be accomplished by using "PROGRAMMING MODE PARAMETER TABLE" on page 4.

Error Messages

No communication with sensor (Sensor and/or cable broken or not connected) : if one of the NTC, PT100, R (/k) or TC input types selected, PErr message will be displayed.
PErr
During an error condition ;
- Minimum output signal value will be displayed for NTC input types,
- Maximum output signal value will be displayed for PT100, R (Ω/kΩ) and TC input types.

LErr Input value is lower than scale value.

HErr Input value is higher than scale value.

Alarm Status

W W W
-24.0
A A A
- Measured value flashes on display in case of alarm.
- Upper and Lower alarm parameters will be changed if input type is change. Therefore, alarm parameter must be re-edited.

Reset Configuration to Default Settings

▼ To reset the device to the original factory default settings, power-up the device while pressing **▼** key, dPAr message appears on display and device resets to default settings.

! When factory reset is performed, all settings are erased.

PROGRAMMING MODE PARAMETER TABLE

Parameter Name	Description	Unit	Min.	Max.	Default Value
i.tYp	Input Type Selection : b, E, j, k, L, n, r, 5, t, U (<i>thermocouple types</i>), Pt (<i>PT100</i>), ntc (<i>NTC</i>), 0-20 (<i>0-20mA</i>), 4-20 (<i>4-20mA</i>), 0-5 (<i>0-5V</i>), 1-5 (<i>1-5V</i>), 0-10 (<i>0-10V</i>) 150 (<i>0-150mV</i>), 550 (<i>0-550</i>), 10k (<i>0-10k</i>), Freq (<i>0-10kHz frequency input</i>)		B	FrEq	ntc
o.tYp	Output Type Selection : 0-20 (<i>0-20mA</i>), 4-20 (<i>4-20mA</i>), 0-5 (<i>0-5V</i>), 1-5 (<i>1-5V</i>), 0-10 (<i>0-10V</i>) FrEq (<i>0-50kHz frequency output</i>)		0-20	frEq	0-20
i.LoL	Input measurement scale lower value limit (minimum value of output signal is given according to this value).		-999	i.upl	-60
i.upl	Input measurement scale upper value limit (the maximum value of the output signal is given according to this value).		i.LoL	9999	150
i.oFF	Input measurement scale offset value	°C/°F	-20	20	0

CONFIGURATION PARAMETERS

Parameter Name	Description	Unit	Min.	Max.	Default Value
Unit	Temperature Unit		°C	°f	°C
d.pnt	Decimal place value positions. 0 (<i>unplaced</i>), 0.0 (<i>single</i>), 0.00 (<i>double</i>), 0.000 (<i>triple</i>)		0	0,000	0
0.pnt	Digital filter coefficient. As the number increases, the sampling accuracy increases, but the sampling time is as specified. (1=250ms, 2=500ms, 3=750ms, 4=1s)		1	4	4

ALARM PARAMETERS

Parameter Name	Description	Unit	Min.	Max.	Default Value
A.LoL	Alarm Lower Limit	°C/°F	0	A.upl	0
A.upl	Alarm Upper Limit	°C/°F	A.LoL	9999	-60
A.hy5	Alarm hysteresis value	°C/°F	0.1	20.0	2
A.dly	Delay time limit in alarm condition	dk:sn	00:00	99:00	01:00

RS485 MODBUS PARAMETERS

Parameter Name	Description	Unit	Min.	Max.	Default Value
adr5	Slave device address		1	247	1
baud	Baudrate 0 : oFF 3 : 4800 1 : 1200 4 : 9600 2 : 2400 5 : 19.20	Bps	off	19.20	9600

SECURITY PARAMETERS

Parameter Name	Description
5.cod	Password parameter used for parameter change and calibration. If 1001 is entered, P.yES and p.no selections are displayed. When P.yES is selected, parameter can be changed.

NOTES :

- (1) When the input type is changed, the upper value of the measuring scale **i.upl** and the lower value of the measuring scale **i.loL** also change. The desired measurement scale should be determined by changing the parameters **i.upl** and **i.loL**.
- (2) The maximum value of output signal shall be given at the upper value (**i.upl**) of the input measurement scale.
The minimum value of output signal shall be given at the lower value (**i.loL**) of the input measurement scale.
- (3) **d.pnt** selection depends on the input type (**i.typ**). Only thermocouple types, PT100 sensor or NTC sensor can be displayed as unplaced decimals (**d.pnt = 0**) or only single decimal place (**d.pnt = 1**) can be displayed. In other input types, all **d.pnt** selections can be used.

ECUC UNIVERSAL CONVERTER MODBUS ADDRESS MAP

1.1 HOLDING REGISTERS

Holding Register Address		Data Type	Parameter Description	Parameter Name	Read / Write Permission
Decimal	Hex				
0000d	0x0000	word	Alarm Lower Limit	A.LoL	R / W
0001d	0x0001	word	Alarm Upper Limit	A.uPL	R / W
0002d	0x0002	word	Lower limit scale for Input measurement	i.LoL	R / W
0003d	0x0003	word	Upper limit scale for Input measurement	i.uPL	R / W
0004d	0x0004	word	Offset Value for Input measurement	i.oFF	R / W
0005d	0x0005	word	Alarm hysteresis value	A.HY5	R / W
0006d	0x0006	word	Input type selection : 0: b, 1: E, 2: j, 3: k, 4: L, 5: n, 6: r, 7: 5, 8: t, 9: U, 10: Pt (PT100), 11: ntc (NTC), 12: 0-20 (0-20mA), 13: 4-20 (4-20mA), 14: 0-5 (0-5 V), 15: 1-5 (1-5 V), 16: 0-10 (0-10V), 17: 150 (0-150mV), 18: 550 (0-550), 19:10k (0-10k), 20: FrEq (0-10kHz)	i.typ	R / W
0007d	0x0007	word	Output type selection : 0: 0-20 (0-20mA), 1: 4-20 (4-20mA), 2: 0-5 (0-5V), 3: 1-5 (1-5V), 4: 0-10 (0-10V), 5: Freq (0-50kHz)	o.typ	R / W
0008d	0x0008	word	Decimal place. 0 (unplaced), 0.0 (single), 0.00 (double), 0.000 (triple)	dpnt	R / W
0009d	0x0009	word	Digital filter coefficient (1=250ms , 2=500ms , 3=750ms , 4=1s)	optn	R / W
0010d	0x000A	word	Delay time duration for Alarm condition	A.dly	R / W
0011d	0x000B	word	Slave device	adr5	R / W
0012d	0x000C	word	Baudrate. 0 : oFF , 1 : 1200 , 2 : 2400 , 3 : 4800 , 4 : 9600 , 5 : 19.20	baud	R / W

1.2 INPUT REGISTERS

Input Register Address		Data Type	Parameter Description	Parameter Name	Read / Write Permission
Decimal	Hex				
0000d	0x0000	word	Measured value	--	Read Only

* Holding Register and Input Register parameters are defined as integer type and these parameters are in decimal. For example, a parameter with a value of 14.0 will be read as 140. Time-related parameters those of type min:sec are defined in seconds and those of type hr:min in minutes.

1.3 COILS

Coil Address		Data Type	Parameter Description	Parameter Name	Read / Write Permission
Decimal	Hex				
00d	0x00	Bit	Temperature unit. OFF= °C , ON= °F	Unit	R / W

* MODBUS CONNECTION DIAGRAM

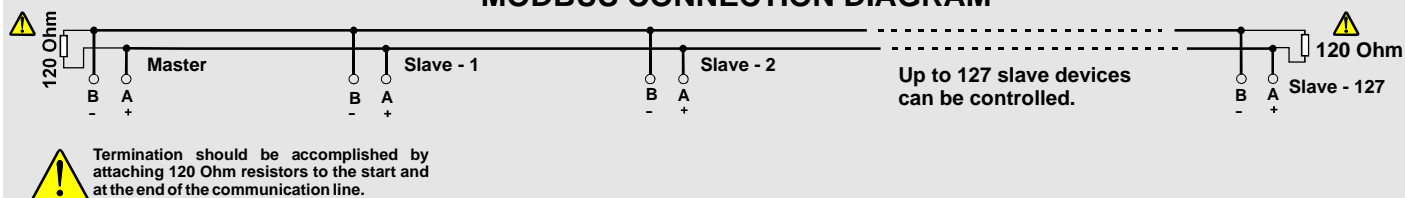

* Applies to devices with Modbus function.